

# DEVELOPMENTS AND NEW APPLICATIONS FOR BIOGENIC SULPHIDE REAGENT IN **HYDROMETALLURGY AND MINERAL PROCESSING**

R.W. LAWRENCE, EXECUTIVE VICE PRESIDENT – BIOTEQ ENVIRONMENTAL TECHNOLOGIES INC., AND C.A. FLEMING, VICE PRESIDENT, GLOBAL METALLURGY – SGS MINERALS SERVICE

## ABSTRACT

In the past year, BioteQ Environmental Technologies Inc. have initiated design and construction of new plants to add to an existing list of plants that utilize the BioSulphide® and ChemSulphide™ process technologies for metal recovery and water treatment. In these plants, low cost biogenic sulfide or, in some cases, chemical sulfide reagent is used to selectively remove metals from contaminated water. The process produces high grade, marketable, metal sulfide products even from low grade feed solutions. The revenues generated from the sale of products can allow for water treatment at a profit in some cases, offset treatment costs in others, and generally reduce sludge disposal and management costs. The effluents produced from the process can meet stringent environmental standards. Current plants in operation and under construction range in sulphide demand from 50 kg/day to 3.7 tonnes/day, with the feasibility of larger plants with sulfide demands ranging from 6 to 43 tonnes/day under review.

Biogenic sulfide reagent can also be considered for other applications in hydrometallurgy and mineral processing. Uses under consideration by a number of mining companies include: (1) replacement of sodium hydrosulphide in the SART process for cyanide regeneration and copper recovery in the processing of gold-copper ores, and (2) replacement of sodium hydrosulphide for use in the separation of copper and molybdenum in flotation. Biogenic sulphide, produced on demand at site, offers significant cost savings and provides the additional benefit of improved safety due to the elimination of the transportation, handling and storage required for chemical sulphide reagents.

This paper reviews the applications of the BioSulphide® and ChemSulphide™ technologies for water treatment and metal recovery, and introduces projects where biogenic sulfide can be applied in hydrometallurgy and mineral processing.

## INTRODUCTION

Sulphide reagents are widely used in mineral processing and hydrometallurgical operations. The use of sodium hydrosulphide, NaHS, to provide conditions in which molybdenum sulphide can be separated from copper sulphides is common practice in flotation. The same reagent is also sometimes used in water treatment following conventional lime treatment to reduce concentrations of residual metals, particularly cadmium. This is successful due to the ability of sulphide to reduce metal concentrations to much lower values than can be achieved by

precipitating metals as hydroxides with lime, although the metals so precipitated are not recovered as they report to the lime sludge. NaHS can also be used to precipitate metals from leach solutions to win metals as high-grade concentrates, although solvent extraction electrowinning is usually preferred particularly for copper. A notable exception is the use of sulphide for the recovery of nickel at the large nickel laterite leaching operations, where the economies of scale permit the use of sulphide in the form of H<sub>2</sub>S generated at site from the reaction of hydrogen gas with molten sulphur. In recent years, the SART process (Sulphidization–Acidification–Recycle–Thickening) has

been developed for use in the processing of gold-copper ores in which NaHS is used to precipitate copper from cyanide leach solutions (Barter et al, 2001; MacPhail et al, 1998).

The use of sulphide reagent lies at the heart of BioteQ's technology and know-how used in its commercial plants to treat water for selective metal recovery and/or producing clean water for environmental discharge (Lawrence et al, 2005; Bratty et al, 2006). Although some smaller BioteQ plants, currently operating or under construction, use NaHS for selective metal precipitation and recovery in a process known as ChemSulphide™, others use sulphide in the form of H<sub>2</sub>S generated from the reduction of elemental sulphur using technology either directly related to the BioSulphide® Process, or used under license.

Sulphide can also be generated from the biological reduction of sulphate, although the generation of sulphide from this source is limited to passive water treatment applications in which low flows containing low concentrations of metals can be treated to precipitate metals in natural wetlands and sediments. For high-rate generation of sulphide for applications involving high-flow and high metal loadings, reduction of elemental sulphur to generate sulphide is more rapid, efficient and cost effective due to the significantly lower power, electron donor and other reagent demands to convert S<sup>0</sup> to S<sup>2-</sup> (2 electrons) compared with SO<sub>4</sub><sup>2-</sup> to S<sup>2-</sup> (8 electrons). Capital costs are also correspondingly much lower. In addition, the reduction of sulphur takes place in a bioreactor in which none of the water to be treated is introduced. This is a very significant advantage over the reduction of sulphate which is contained in the water to be treated and that process is therefore exposed to the risks associated with fluctuating flows and water chemistry.

A simple schematic illustrating the production of sulphide reagent as hydrogen sulphide through the biological reduction of elemental sulphur is shown in Figure 1.

The sulphide reagent is produced by reacting elemental sulphur in a bioreactor with an electron donor, such as acetic acid, in the presence of sulphur-reducing bacteria under anaerobic conditions according to reaction (1).

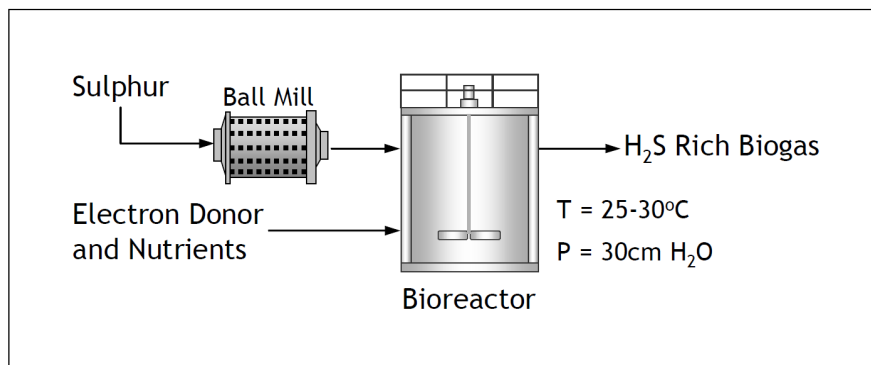
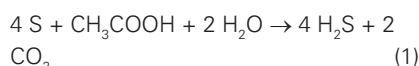

Figure 1: Biological generation of hydrogen sulphide gas



The sulphur-reducing bacteria act as a catalyst enabling reaction (1) to proceed at 25° C and at a system pressure of +30 cm WC. A continuous production of H<sub>2</sub>S is achieved by removing the gaseous products of the reaction (1) from the bioreactor. Since elemental sulphur is used as the sulphur source for making H<sub>2</sub>S, instead of sulphate, no process water other than that contained in the reagents required for reaction (1) enters the bioreactor. Thus the bioreactor is a true standalone H<sub>2</sub>S generator.

The main advantages of using the biological H<sub>2</sub>S generation include:

- Low cost of sulphide compared to the cost of Na<sub>2</sub>S, NaHS, or H<sub>2</sub>S;
- Minimal hazards and increased safety mainly due to the low system pressure and low inventory of H<sub>2</sub>S. At any point in time the amount of H<sub>2</sub>S stored in the bioreactor(s) is a small fraction of the daily H<sub>2</sub>S production. This allows the avoidance of special environmental permitting for sulphide reagent storage;
- Low capital cost mainly due to the ambient temperature and pressure in bioreactors that are designed as conventional stirred tanks compared to pressure vessels with expensive agitator seals; and
- Easy to scale-up and down over a wide range of H<sub>2</sub>S production capacities.

## OPERATING PLANTS AND DEVELOPING PROJECTS FOR WATER TREATMENT AND METAL RECOVERY

Since 2001, BioteQ has constructed and operated three commercial operations utilizing sulphide generation

and precipitation technology (Caribou Mine in New Brunswick, Copper Queen Mine in Bisbee, Arizona, and the Raglan Mine, in northern Quebec), as well as operating conventional lime treatment plants and a tailings reclamation and re-treatment operation, also at the Caribou Mine and the nearby Restigouche Mine. The Bisbee and Raglan plants provide two typical examples of operating plants utilizing the BioSulphide® and ChemSulphide™ processes, respectively.

### BISBEE, ARIZONA

BioteQ's success with the plant constructed and operated at the Copper Queen Mine in Bisbee, Arizona, owned by Phelps Dodge, has opened up numerous opportunities to use biogenic sulphide generation for the recovery of metals including copper, nickel, zinc and cobalt at a number of sites around the world. The recovery of copper at Bisbee has demonstrated that the technology has a niche for profitable operation for the treatment of solutions too low grade for economic application of SX-EW and with a significant lower capital investment.

The Bisbee plant, commissioned in 2004 and designed to recover up to 3 million pounds per year of copper from flows of up to 10,900 m<sup>3</sup>/day, is operated by Copreco LLC, the joint venture company between BioteQ and Phelps Dodge. The plant is recovering copper from the drainage of a large low-grade stockpile. Copper had previously been recovered by cementation with iron but is now precipitated into a high-grade copper sulphide concentrate using hydrogen sulphide generated in a bioreactor in which elemental sulfur is reduced as

shown in Figure 1.

A simple schematic of a metal recovery plant at Bisbee is shown in Figure 2. Drainage from the Bisbee stockpile is mixed with the hydrogen sulphide gas in an agitated contactor tank. Precipitation of copper is rapid and highly efficient, with copper recoveries consistently greater than 99.5% from the feed solution containing copper in the range 260 to 360 mg/L at a flow of 8000 to 9000 m<sup>3</sup>/day, depending in the season. The copper sulphide product is then thickened and dewatered using conventional equipment, with the plant effluent returned to the stockpile. The filtered concentrate, containing typically 40 to 45% copper, is shipped to the Phelps Dodge owned smelter in Miami, Arizona for processing to metal.

Some mechanical issues during and 2005 and the early months of 2006 caused some significant downtime. However, the necessary repairs and replacement of some equipment, together with improved operational procedures, have resulted in very high plant availability in the second half of 2006, with monthly copper recoveries of around 150,000 lb per month being achieved at current solution grades and flow rates. Payback on the US\$3.2 million plant is expected to be less than 3 years.

#### RAGLAN, QUEBEC

The Raglan Mine in Northern Quebec is owned and operated by Xstrata Nickel (formerly Falconbridge). The water treatment plant at Raglan employs a unique nickel treatment process, utilizing BioteQ's ChemSulphide™ Process, to selectively recover nickel from low grade contaminated mine water. The treated water quality produced in the plant can be released directly into the pristine local environment and no by-product sludge is produced for long term storage.

The BioteQ plant was commissioned in 2004, with the first full year of operations in 2005 reported previously (Jones et al, 2006). The plant, which is owned and operated by BioteQ, was constructed in response to the need by the mine owner to provide an alternative method to treat increasing volumes of contaminated

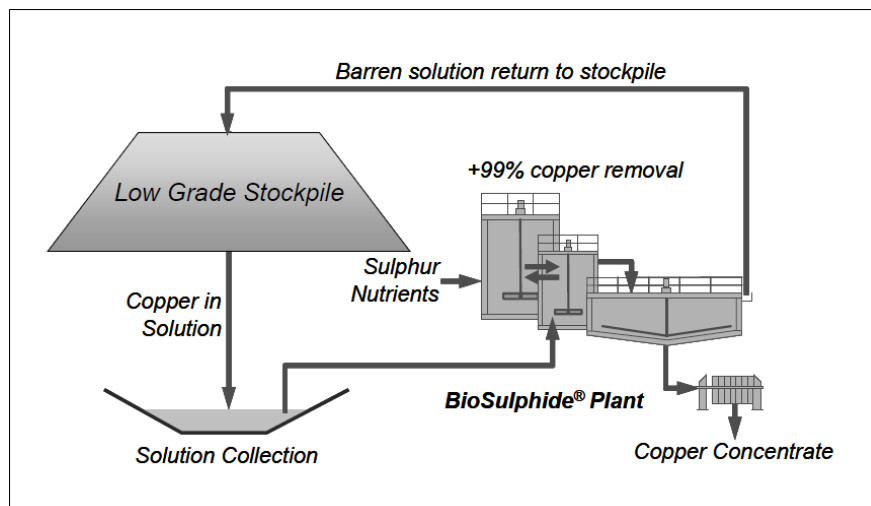

Figure 2: Simplified flowsheet showing the use of biogenic sulphide for copper recovery at Bisbee

drainage that was not responding optimally to treatment with lime due to difficulties in settling the very low density sludge in the cold water at the site.

Figure 3 provides a simple flowsheet of the process. Contaminated surface drainage water at the site is collected in a large containment basin and pumped to the BioteQ plant where sodium hydrosulphide is used to precipitate the nickel contained in the water. The nickel sulphide precipitate is dewatered and shipped periodically to the Raglan concentrator where it is added to the flotation concentrate for shipment to the smelter. Effluent from the plant passes through polishing filters before being discharged to the environment. Patent application is in progress for the BioteQ process that was developed between 2001 and 2003 for the Raglan site, and which can be applied to other nickel-bearing waste streams. The decision by BioteQ to use the ChemSulphide™ process rather than using a bioreactor to generate sulphide was due both to the short treatment season and the relatively low sulphide demand.

BioteQ completed its second full operating season at Raglan in November, 2006,

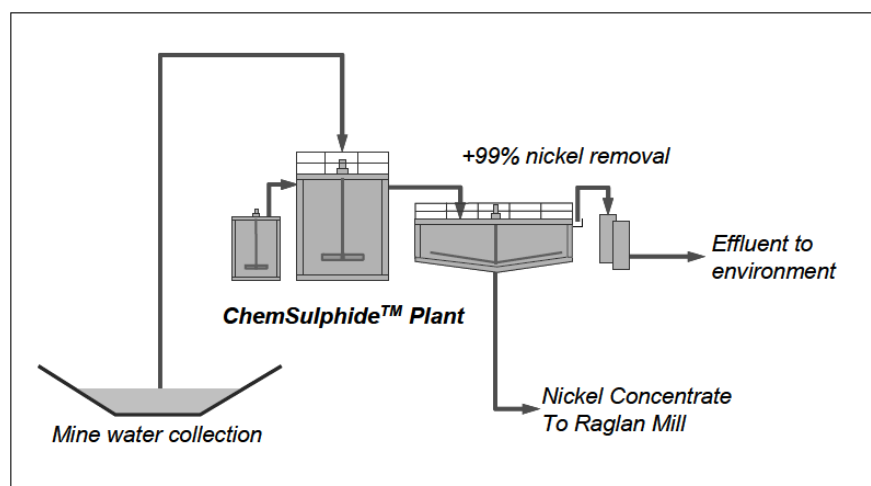

Figure 3: Simplified flowsheet showing the use of sulphide precipitation technology at the Raglan Mine.

when the water treatment plant was placed in stand-by mode for the duration of the winter, which is the normal operating practice for this site. It is expected that normal operations will resume in May of 2007, subject to local weather at that time. The total treated water discharged from the plant during the five and a half months operating season in 2006 was 816,000 cubic meters, which is 16.5% more than the budgeted treatment target. The 2006 total water treated is approximately 50% greater than the original design capacity as a result of process modifications made in 2005 as well as

increase in operating availability resulting from improved operations management. The treated water was maintained at less than 0.2 mg/L nickel concentration to meet the regulated discharge criteria of <0.5 mg/L total nickel content. The plant operating costs for labour and consumables met budget expectations.

BioteQ began planning for ISO 14001 accreditation in 2005. The environmental management system to meet the stringent requirements of ISO 14001 was initiated during the 2005 operating season and the plant received ISO 14001 accreditation in 2006. The ISO 14001 management system will now be implemented at other BioteQ sites.

### DEVELOPING PROJECTS

In addition to optimizing BioteQ's existing operations, the company is looking towards several new water treatment and metal recovery projects. Projects that are due for construction in 2007 include a copper recovery plant at the Dexing mine in Jiangxi Province, China. BioteQ signed a joint venture agreement with the mine's owner, Jiangxi Copper Corporation, in 2006 for the construction and operation of a plant which will have a minimum capacity of 1.1 million pounds per year of copper and a maximum of 4.5 million pounds per year if all acidic water at the site is treated.

Also scheduled for construction and operation in 2007 is a treatment plant at the closed Wellington-Oro mine in Colorado. The old zinc-silver mine, located near to the town of Breckenridge, produces an acidic wastewater that requires treatment before discharge to the French Gulch tributary of the Blue River. BioteQ's plant has been designed to treat the water and recover zinc and cadmium into a zinc-rich concentrate product for shipment off site for final refining. The BioteQ technology was selected as the best available technology for the site by the Town of Breckenridge, Summit County and the US Environmental Protection Agency not only due to its ability to achieve the stringent demands for very low residual concentrations of zinc and cadmium in the plant effluent, but also due to the fact that no sludge is produced that would require a site for

long-term storage in an area of intensive recreational use and high land values.

BioteQ is also currently working with Columbia Metals Corporation Ltd., Canada, to apply its sulphide generating and precipitation technology at both Columbia's La Jojoba and Lluvia de Oro projects in northern Mexico. Both mines are gold mines but are metallurgical challenging due to the presence of cyanide-soluble copper. In these applications, biogenic sulphide would be used in place of chemical sulphide reagents to recover copper as part of the SART process to be discussed in the following section.

### OTHER APPLICATIONS IN MINERAL PROCESSING AND HYDROMETALLURGY

Biogenic sulphide reagent can also be considered for other applications in hydrometallurgy and mineral processing. Uses under consideration by a number of mining companies include: (1) replacement of sodium hydrosulphide in the SART process for cyanide regeneration and copper recovery in the processing of gold-copper ores, and (2) replacement of sodium hydrosulphide for use in the separation of copper and molybdenum in flotation. Biogenic sulphide, produced on demand at site, offers significant cost savings and provides the additional benefit of improved safety due to the elimination of the transportation, handling and storage required for chemical sulphide reagents.

**Biogenic Sulphide Reagent For SART**  
Many of the known gold deposits in the world contain cyanide-soluble copper minerals such as chalcocite, covellite, bornite, cuprite, malachite and azurite. The fact that the ore is not currently being mined in many of these cases has been due, in no small measure, to the metallurgical challenges and high cost of treating the cyanide-soluble copper minerals in the ore. The presence of leachable copper in a gold ore body results in low gold recovery and/or high cyanide consumption and destruction costs, as well as complications in the gold recovery circuit, whether gold recovery is by adsorption on activated carbon, electrolysis or cementation on

zinc dust.

One way in which gold plant operators have attempted to deal with the problem in the past has been to limit cyanide addition to the leach liquor to starvation levels, in the hope of selectively leaching gold and leaving copper in the residue. This has the desired effect of reducing the formation of copper cyanide and reducing cyanide consumption, but is invariably achieved at the cost of reduced gold recovery.

The SART Process (Sulphidization, Acidification, Recycling, Thickening), which was developed into a practical, commercial process by SGS Lakefield Research and Teck Corporation (MacPhail et al, 1998), releases the cyanide associated with the copper cyanide complex, allowing it to be recycled back to the leach process as free cyanide, and also recovers the copper as a valuable, high-grade  $\text{Cu}_2\text{S}$  by-product (~70% Cu). The implementation of this technology allows gold/copper ore bodies to be leached aggressively with cyanide (thereby maximizing gold recovery), without undue concern for copper cyanide formation. The SART process also converts zinc cyanide in a leach liquor (which is often the case if the Merrill Crowe process is used for gold and silver recovery) to free cyanide and the ZnS precipitate.

The SART Process, as originally developed (MacPhail et al, 1998; Barter et al, 2001), uses chemical sulphide ions, such as sodium hydrosulphide (NaHS), to precipitate copper and zinc (if present) and convert cyanide to HCN gas, under weakly acidic conditions (pH 5).

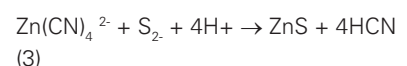
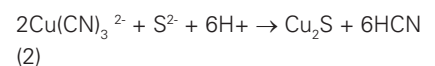

These reactions are very favourable, owing to the extremely low solubility of  $\text{Cu}_2\text{S}$  and ZnS. The reaction of sulphide with zinc cyanide is even more favourable than the copper reaction, and takes place under alkaline conditions (pH 10), because the product (ZnS) is essentially insoluble in alkaline cyanide

solution. This affords the opportunity of producing separate ZnS and Cu<sub>2</sub>S precipitates, if there is commercial advantage in doing so.

Because these reactions are so favourable, sulphide and acid addition rates are close to stoichiometric according to equations (2) and (3), based on the concentration of copper and/or zinc in solution (half mole sulphide per mole copper), and cyanide in solution, respectively (one mole H<sup>+</sup> per mole cyanide). This has been demonstrated in laboratory and pilot plant trials.

HCN is a very soluble gas, and remains in solution until the Cu<sub>2</sub>S or ZnS is removed by thickening and filtration. It is then neutralized with lime or caustic soda (lime will generally be preferred for cost reasons), prior to recycling to leach.

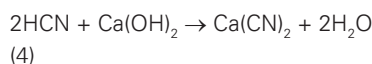

The chemical sulphide that was used in the original SART developments can readily be replaced by a lower cost source of sulphide ions, such as biogenically-produced hydrogen sulphide, which has the added advantage of lowering the acid demand by one third for copper cyanide treatment and half for zinc cyanide.

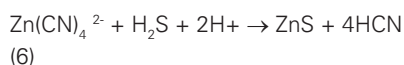
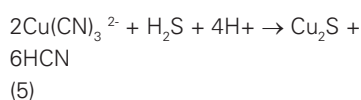

A simplified process flowsheet in which biogenic sulphide replaces chemical sulphide in the SART Process is shown in Figure 4.

Although HCN is a very soluble gas, with low vapour pressure at ambient temperatures, some gas will accumulate in the vapour phase above an acidic solution containing HCN. To avoid cyanide losses via release of this highly toxic gas to the environment, the primary reactor and the thickener in the SART process have to be closed vessels, with the gas phase being vented to a scrubber (caustic or lime). A small percentage

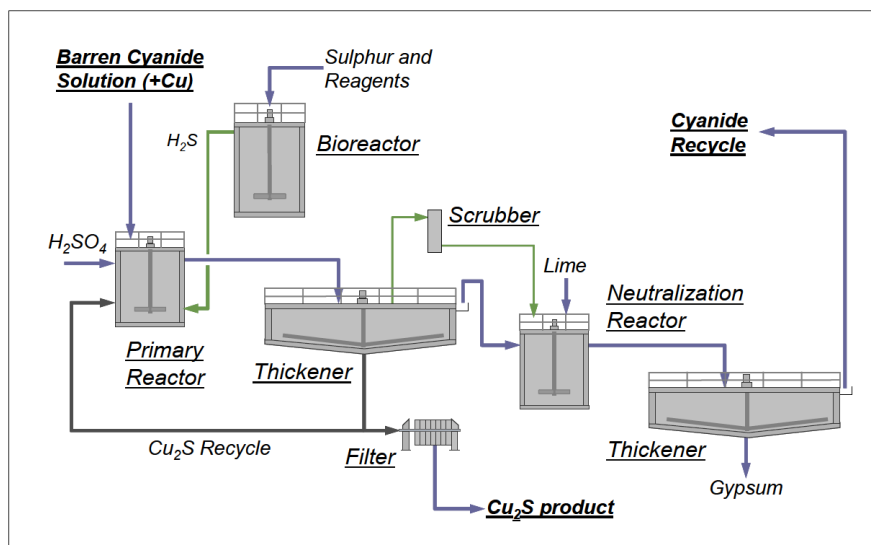

Figure 4: Flowsheet showing the use of biogenic sulphide to replace chemical sulphide in the SART Process for cyanide recycle and copper recovery in gold-copper ore processing

of the total cyanide recovered in the process is recovered in the scrubber.

As can be deduced from Figure 4, one of the features of the SART process (compared to other cyanide recovery processes such as AVR and Cyanisorb™), is the fact that cyanide is not preconcentrated prior to recycling. The cyanide strength of the regenerated cyanide solution is essentially the same or slightly lower than the cyanide strength of the tailings being treated. The process is therefore ideally suited to heap leach operations, where barren solution (after gold recovery) is recycled directly to leach. Nonetheless, the first industrial application for the technology was at the Telfer Mine in Western Australia, where the process was used to regenerate copper cyanide-rich tailings from a CIP plant. For the SART process to be applied in this way to pulps in a milling operation, the tailings must be subjected to solid/liquid separation (filtration or CCD), prior to SART. In order to maximize cyanide recovery, the wash solution used in CCD or filtration must be free of cyanide and the combined wash plus barren solution must be treated by the SART process. This will produce a large volume of low-grade free cyanide solution, and even if the maximum amount of this water is recycled to the mill and the leach tanks, excess free cyanide-containing water will be produced in the process. Ideally, this water should be directed to a heap leach operation so as not to waste the cyanide,

provided there is a heap leach at the same site as the mill. This was the case at Telfer. This is shown schematically in Figure 5.

The strength of the copper price in the current market makes a most compelling economic case for implementation of the SART process. The sale of a high grade copper sulphide by-product will not only cover all operating costs associated with the SART process (allowing cyanide to be regenerated at zero cost) but will add value to the project by generating additional revenues from any copper that is leached by cyanide in the process. As a result of the very robust copper market conditions, the metal has gone from being a project-killer in many gold ore bodies around the world, to an added-value by-product. For example, the operating cost based on the stoichiometries shown in equation 2 (reagents, power, labour) for treatment of a barren leach solution containing 250 mg/L Cu and 310 mg/L WAD cyanide in a SART circuit can be estimated to be \$0.40 per m<sup>3</sup>, using H<sub>2</sub>SO<sub>4</sub>, NaHS and Ca(OH)<sub>2</sub> costs of \$100/t, \$1000/t and \$250/t, respectively. (Note: the cost would be reduced by the use of biogenic sulphide in place of chemical reagents such as sodium hydrosulphide). Assuming recoveries of 95% cyanide and 99% copper, unit costs of NaCN and copper of \$0.69/lb and \$2.50/lb, respectively, and a net smelter return of 85% for sale of the copper, revenues of \$1.98 per m<sup>3</sup> can be estimated. Half

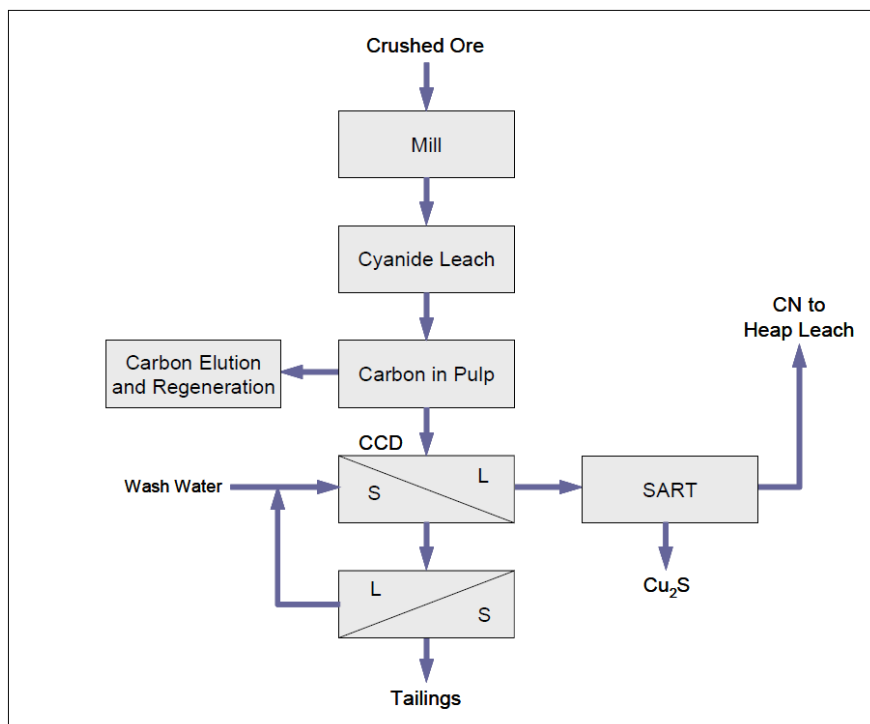

Figure 5: Incorporation of a SART circuit in a CIP gold leach flowsheet for copper recovery and cyanide recycle as practiced at the Telfer Mine, Australia

of this revenue stems from the sale of copper sulphide, illustrating the potential added value of the leachable copper in a gold ore.

SART therefore offers a significant operating cost advantage to overcome the metallurgical challenges presented by cyanide-soluble copper, compared with alternative methods such as treating a bleed stream in a cyanide detox process (i.e. the SO<sub>2</sub>-air process) to control the buildup of copper. The cost of cyanide detox ranges from \$1.50/kg NaCN to \$3/kg NaCN, depending on the method used and the presence and concentration of other species in the leach liquor. Under the most favourable circumstances, the cost of cyanide detox in the above hypothetical example would be about \$0.90/m<sup>3</sup> of heap leach liquor treated. Therefore, the true benefit of the SART process (versus the conventional alternative) in the prevailing economic climate the mining industry finds itself in (reagent cost and commodity pricing), is expected to be in excess of \$2 per cubic meter of heap leach liquor treated.

The capital cost of a SART plant will be higher than a cyanide detox plant, but this will be more than offset by the

revenues generated by copper recovery and the savings realized by cyanide recycle, allowing for a short pay back time on the incremental capital.

**BIOGENIC SULPHIDE REAGENT IN COPPER-MOLYBDENUM SEPARATION**

As with the SART Process, biogenic sulphide could replace sodium hydrosulphide in mineral processing for the separation of copper and molybdenum in flotation. BioteQ is currently evaluating a number of

opportunities to supply reagent in an arrangement in which they would own and operate the sulphide generating plant at the mine site and supply the reagent to the mine owner/operator. Sodium hydrosulphide is used to provide reducing conditions to permit efficient separation of copper and molybdenum sulphides in many flotation operations around the world. Although NaHS is very effective for this purpose, it could be replaced by biogenic sulphide reagent as shown in Figure 6. The existing NaHS storage and delivery systems could remain in place and operable so that sulphide system availability can remain high in the event of planned or unplanned maintenance of the biogenic system.

Use of biogenic sulphide in copper-molybdenum flotation would have several advantages including:

- Lower cost than NaHS;
- Significantly reduced transportation and storage issues since biogenic reagent is produced on-demand at the mill site;
- No requirement to reduce pH to around 8 for optimum Cu-Mo separation by adding acid or CO<sub>2</sub> due to the highly alkaline NaHS; and
- Adding a biogenic sulphide supply system to an existing NaHS system would allow for very high overall

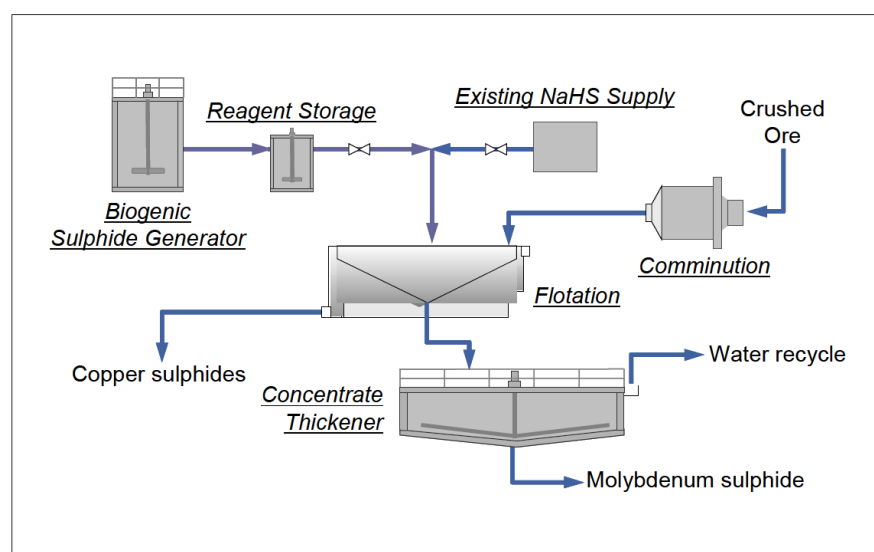

Figure 6: Simplified flowsheet showing the use of biogenic sulphide to replace chemical sulphide in Cu-Mo separation by flotation

system availability in the event of maintenance or problems with reagent market shortages.

## CONCLUSIONS

Sulphide reagents are widely used in the mining, mineral processing and hydrometallurgy in a number of applications including water treatment, metal recovery and flotation. BioteQ utilizes sulphide reagent in its water treatment and metal recovery plants, either as chemical sulphide in the ChemSulphide™ Process, or generated biologically in the BioSulphide® Process or related technology. Successful commercial operations have shown that high quality effluents can be produced for environmental discharge and that metals can be recovered selectively into saleable high-grade concentrates from acid mine drainage or leach solutions. The generation of lowercost biogenic sulphide reagent also offers additional applications in hydrometallurgy and mineral processing. The replacement of chemical sulphide reagents by biogenic sulphide in the SART process offers a further cost advantage to a technology which has great potential to permit the economic processing of many previously

uneconomic gold-copper ores by recovering and recycling cyanide that has been complexed by cyanide-soluble copper, as well as recovering the copper in a saleable sulphide concentrate. Similarly, biogenic sulphide can be used to replace or provide a low-cost alternative/back up system for chemical sulphide used in the separation of copper and molybdenum in flotation.

## REFERENCES

Barter, J., Lane, G., Mitchell, D., Kelson, R., Dunne, R., Trang, C., Dreisinger, D. "Cyanide management by SART". In: Cyanide: Social, Industrial and Economic Aspects, ed. C. Young, TMS (The Minerals, Metals and Materials Society), 549-562, 2001.

Bratty, M., Lawrence, R.W., Kratochvil, D., Marchant, P.B. "Applications of biological H<sub>2</sub>S production from elemental sulphur in the treatment of heavy metal pollution including acid rock drainage". Proc. International Symposium on Acid Rock Drainage (ICARD), St. Louis, March 26-29, 2006.

Jones, L., Bratty, M, Kratochvil, D. Lawrence, R.W. "Biological sulphide production for process and

environmental applications". Proc. Canadian Mineral Processors Operators Conference, Ottawa, January, 2006

Lawrence, R.W., Kratochvil, D., Ramey, D. "A new commercial metal recovery technology utilizing on-site biological H<sub>2</sub>S production". Proc. HydroCopper 2005 – 3rd International Workshop on Copper Hydrometallurgy. Santiago, Chile, November 23-25. 2005

MacPhail, P.K., Fleming, C.A., Sarbutt, K.W. "Cyanide recovery by the SART process for the Lobo-Marte Project, Chile". Randol Gold and Silver Forum, Denver, April 26-29. 1998.

## CONTACT INFORMATION

Email us at [minerals@sgs.com](mailto:minerals@sgs.com)

[WWW.SGS.COM/MINERALS](http://WWW.SGS.COM/MINERALS)

© 2011 SGS. All rights reserved. The information contained herein is provided "as is" and SGS does not warrant that it will be error-free or will meet any particular criteria of performance or quality. Do not quote or refer any information herein without SGS' prior written consent. Any unauthorized alteration, forgery or falsification of the content or appearance of this document is unlawful and offenders may be prosecuted to the fullest extent of the law.